

INTERIM REPORT FIRST QUARTER 2016

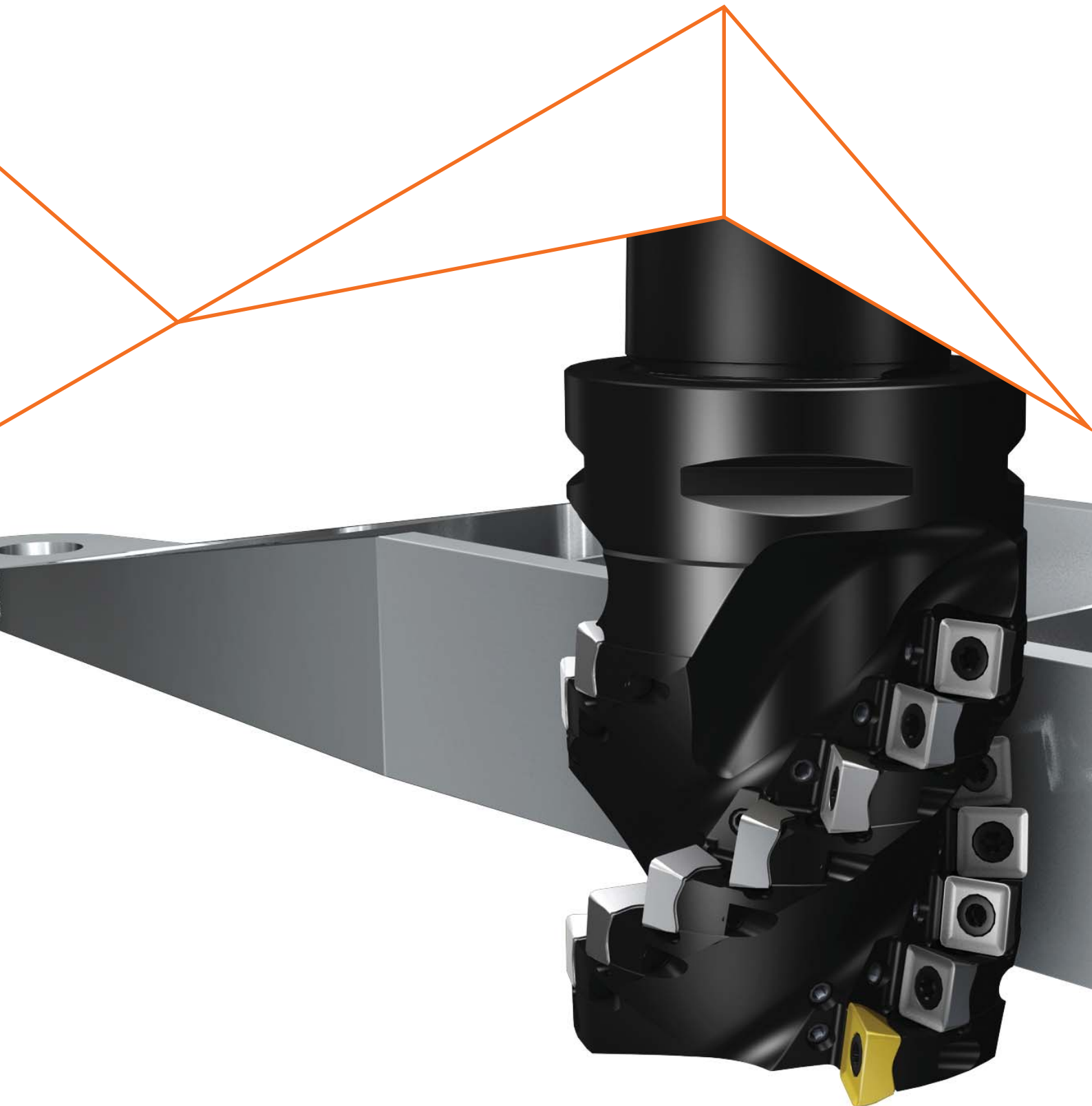

POSITIVE BOOK-TO-BILL IN TOUGH MARKET, ACTIONS TO IMPROVE STRUCTURE

CEO'S COMMENT: "Although the first quarter of 2016 was characterized by a challenging market environment, we managed to deliver results in line with our plans and expectations. We also made progress in structuring Sandvik as a more efficient and agile group by announcing the merger of two business areas," says Björn Rosengren, President and CEO of Sandvik.

"Order intake declined in absolute terms, however we reported a positive book-to-bill in four out of five business areas. Among the major geographical regions, Europe noted a robust positive growth in order intake, supported by large orders, while North America and Asia declined significantly. Demand in the energy segment declined year on year. The underlying sentiment among customers in the mining segment remained weak, with a slight softening noted in the aftermarket business. Customer activity in the automotive segment remained generally stable while we noted a decline in the general engineering segment."

"Adjusted operating profit declined by -19%, negatively impacted by lower revenues as well as significant adverse impact due to changed exchange rates."

"As a result of the ongoing review of operations we made progress in consolidating Sandvik's structure, announcing the merger of Sandvik Mining and Sandvik Construction's operations, forming the new business area Sandvik Mining and Rock Technology.

These operations already largely share manufacturing resources, their products share common technologies and the aftermarket offering of both businesses is similar. By combining the operations into one business area and moving more operational decision-making in to the product areas we achieve a clearer focus and faster response to customers."

"Cash flow from operations was 1.6 billion SEK for the quarter, and net working capital declined, compared with the year-earlier period. We reduced our net debt and net gearing amounted 0.69, down both year on year and in relation to the preceding quarter.

"As of 1 April Tomas Eliasson is on board as new CFO, and I look forward to his contributions to further improving Sandvik's performance".

FINANCIAL OVERVIEW, MSEK	Q1 2015	Q1 2016	CHANGE %	Q1-4 2015
<i>Continuing operations</i>				
Order intake ¹⁾	22 574	20 299	-7	83 597
Revenues ¹⁾	21 960	19 700	-7	85 845
Gross profit	7 339	7 614	+4	30 606
% of revenues	33.4	38.6		35.7
Operating profit	1 199	2 413	+101	7 271
% of revenues	5.5	12.2		8.5
Adjusted operating profit ²⁾	2 977	2 413	-19	10 593
% of revenues ²⁾	13.6	12.2		12.3
Profit after financial items	720	1 996	+177	5 308
% of revenues	3.3	10.1		6.2
Profit for the period	567	1 455	+157	3 443
% of revenues	2.6	7.4		4.0
of which shareholders' interest	572	1 460	+155	3 496
Earnings per share, SEK ³⁾	0.46	1.16	+155	2.79
Return on capital employed, % ⁴⁾	11.9	11.2		9.5
Cash flow from operations	+2 670	+1 602	-40	+12 793
Net working capital, %	29	28		27
<i>Discontinued operations</i>				
Profit for the period	-157	-57	+64	-1 249
Earnings per share, SEK ³⁾	-0.13	-0.04	N/M	-1.00
<i>Group Total</i>				
Profit for the period	410	1 398	+241	2 194
Earnings per share, SEK ³⁾	0.33	1.12	+238	1.79

1) Change from the preceding year at fixed exchange rates for comparable units

2) Operating profit adjusted for nonrecurring charges of 1.8 billion SEK for the first quarter 2015.

3) Calculated on the basis of the shareholders' share of profit for the period
No dilutive impact during the period

4) Rolling 12 months

Tables and calculations do not always agree exactly with the totals due to rounding

Comparisons refer to the year-earlier period, unless stated otherwise

MARKET DEVELOPMENT AND EARNINGS

GROWTH

Q1	ORDER INTAKE	REVENUES
Price/volume, %	-7	-7
Structure, %	+0	+0
Currency, %	-4	-4
TOTAL, %	-10	-10

Change compared to same quarter last year. The table is multiplicative, i.e. the different components must be multiplied to determine the total effect.

In the first quarter, order intake declined by -7% in fixed currency for comparable units. Europe reported positive growth of 7% year on year. Both North America and Asia declined significantly; -26% and -8% respectively. Adjusted for large orders, North America declined by -14%. In Asia, China weighed on regional growth, reporting weaker demand in most customer segments. All business areas reported negative organic growth in order intake. Among the five business areas, Sandvik Machining Solutions - the largest business area - reported the least severe decline in organic order intake at -4%. Sandvik Venture reported the most significant fall of -13%, primarily due to low customer activity in the energy segment. The low activity level in the energy segment impacted Sandvik Materials Technology adversely in the standard and core tubular product offering, however large orders were booked for the capex driven, oil & gas-related tubular offering. The aerospace segment was still strong with healthy customer activity. The mining segment remained challenging, with continued weak demand for equipment, coupled with a slight decline in the aftermarket business compared with the year-earlier period. Demand in the automotive segment remained generally stable. Overall demand in the general engineering segment softened, with Europe being the stronger region in relative terms.

Changed exchange rates had a negative impact of about -4% on both order intake and revenues.

The decline in invoiced volumes and negative impact from changed exchange rates more than offset the positive impact from savings measures, and adjusted operating profit fell by -19% year on year to 2,413 million SEK (2,977) with an operating margin of 12.2% (13.6). Savings from the announced ongoing structural and other improvement programs amounted to 253 million SEK compared with last year, including a reduction in administration and selling costs with the largest decline noted for Sandvik Machining Solutions. The strengthening of the SEK against several trading currencies had an adverse impact of about -375 million SEK in the quarter (770), with Sandvik Mining sustaining the largest impact. Changed metal prices negatively impacted results by -106 million SEK (-5). The tax rate in the first quarter was 27.1% (21.3) for continuing operations, and the total tax rate for the Group was 27.9% (27.2) for the quarter.

REVENUES AND BOOK-TO-BILL

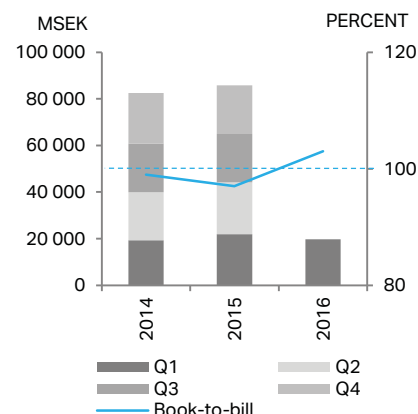

OPERATING PROFIT & RETURN

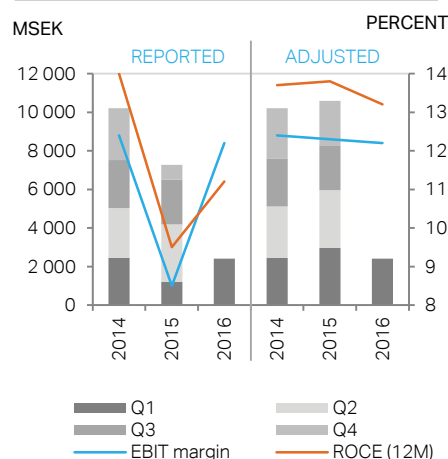

EARNINGS PER SHARE

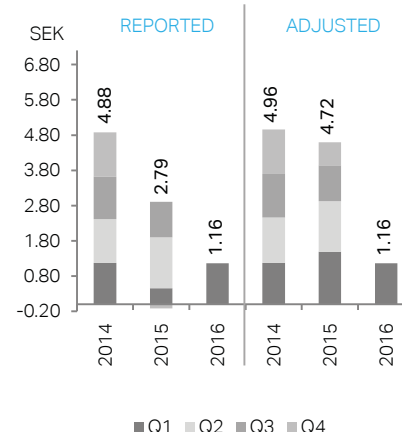

CASH FLOW AND BALANCE SHEET

Total assets for the Group decreased year on year primarily due to the impact of changed exchange rates as well as the reduction in net working capital. Total assets remained largely stable compared with the preceding quarter.

Net working capital decreased by about 3.5 billion SEK year on year to a total of 22.4 billion SEK. The decrease was supported by the focused volume reduction of net working capital during 2015 and, to some extent, by the impact from changed exchange rates. Net working capital in relation to revenues declined to 28% (29). Compared with the preceding quarter, there was a seasonal build-up of net working capital.

Capital expenditure in the first quarter amounted to 741 million SEK (793). Investments were low in the first quarter, in line with the normal seasonal pattern.

Financial net debt amounted to 27.2 billion SEK in the first quarter, declining both year on year (30.4) and in relation to the preceding quarter (28.2). Consequently, the net debt to equity ratio decreased to 0.69, below the long-term target of below 0.8, and down from 0.72 in the year-earlier period and 0.74 in the preceding quarter. Interest-bearing debt with short-term maturity accounted for 15% of total debt. The net pension liability was 6 billion SEK.

Cash flow from operations amounted to 1.6 billion SEK (2.7). The lower level of operating cash flow compared with the preceding year is primarily related to the slight increase in volume of net working capital.

CASH FLOW FROM OPERATIONS

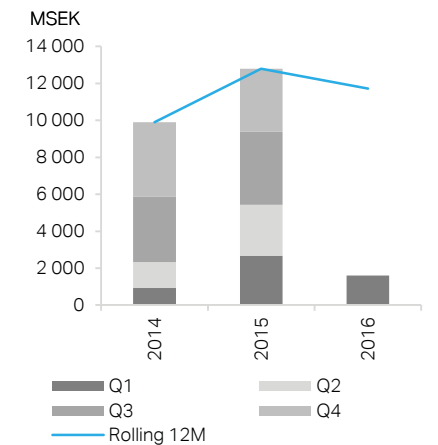

NET WORKING CAPITAL

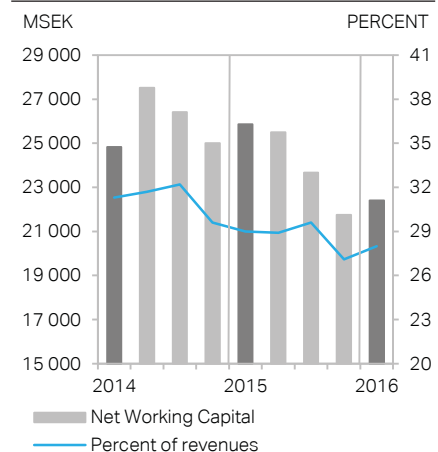

NET DEBT

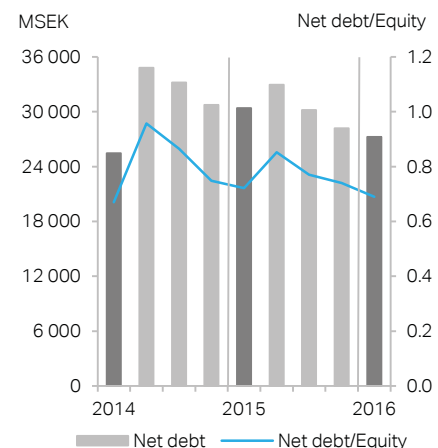

SANDVIK MACHINING SOLUTIONS

NEGATIVE GROWTH IN ASIA AND NORTH AMERICA, EUROPE STABLE

EARNINGS SUPPORTED BY SAVINGS...

...BUT LOWER VOLUMES AND CHANGED EXCHANGE RATES HAD ADVERSE IMPACT



GROWTH

Q1	ORDER INTAKE	REVENUES
Price/volume, %	-4	-5
Structure, %	+0	+0
Currency, %	-2	-2
TOTAL, %	-6	-8

Change compared to same quarter last year. The table is multiplicative, i.e. the different components must be multiplied to determine the total effect.

Overall, demand in Europe remained stable, while North America and Asia declined by -10% and -8%, respectively.

Key differences in the market situation compared with the year-earlier period:

- weak demand in the energy segment
- declining customer activity in the general engineering segment across all regions
- the automotive segment generally remained flat, comprising a slight decline in North America - although the region remained at a high level. Small improvement in Europe and stable performance in Asia
- the overall business activity in Asia declined, negatively impacted by weaker demand in China where aerospace was the stronger segment in relative terms, noting slightly positive growth
- in Europe, positive performance in the east, was offset by negative development in the west

The deviation between order intake and revenues was slightly larger than normal, primarily due to the intake of orders with scheduled deliveries through the year.

Operating margin of 20.3% despite negative organic growth of -5% and negative impact from changed exchange rates. Adjusted for the impact of changed exchange rates, the operating margin improved year on year.

Items impacting operating profit and margin:

- positive impact from savings from structural measures partially offset negative impact from lower volumes in production
- compared with the year-earlier period, ongoing announced structural efficiency measures generated savings of about 90 million SEK, yielding an annual run rate of 360 million SEK

- changed exchange rates had a negative impact on operating profit of about -160 million SEK (410)

Net working capital in relation to revenues was reported at a low 24.2% (24).

ORDER INTAKE, REVENUES AND BOOK-TO-BILL

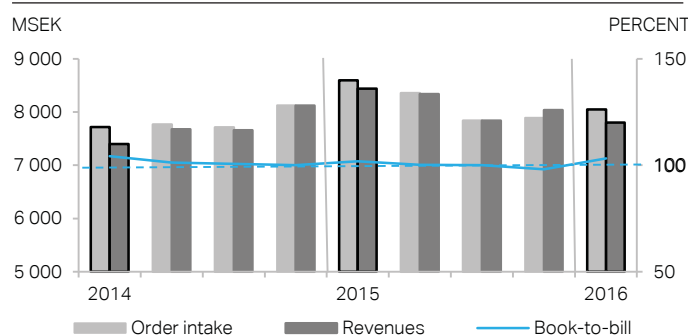

OPERATING PROFIT AND RETURN

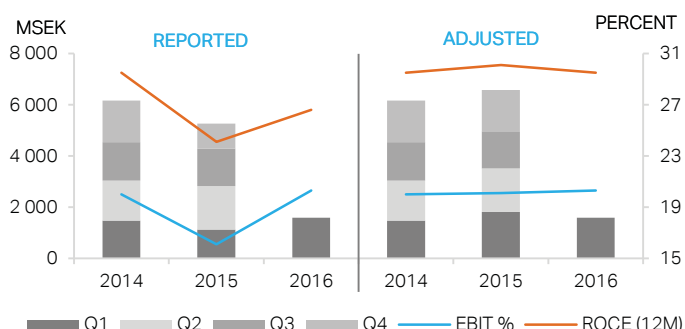

FINANCIAL OVERVIEW, MSEK

	Q1 2015	Q1 2016	CHANGE %	Q1-4 2015
Order intake	8 596	8 050	-4 *	32 682
Revenues	8 438	7 803	-5 *	32 652
Operating profit	1 129	1 587	+41	5 269
% of revenues	13.4	20.3		16.1
Adjusted operating profit**	1 809	1 587	-12	6 579
% of revenues**	21.4	20.3		20.1
Return on capital employed, %***	27.1	26.6		24.1
Number of employees	18 838	17 804	-5	18 120

* At fixed exchange rates for comparable units. ** Operating profit adjusted for nonrecurring charges of 680 million SEK in Q1 2015. *** Rolling 12 months

SANDVIK MINING

HIGH MARKET UNCERTAINTY

CHANGED EXCHANGE RATES IMPACTED EARNINGS

NEW BUSINESS AREA AS OF 1 JULY 2016 - MINING AND ROCK TECHNOLOGY



GROWTH

Q1	ORDER INTAKE	REVENUES
Price/volume, %	-8	-1
Structure, %	+0	+0
Currency, %	-9	-9
TOTAL, %	-16	-10

Change compared to same quarter last year. The table is multiplicative, i.e. the different components must be multiplied to determine the total effect.

Organic order intake declined by -8%, as customer activity softened for both the equipment and aftermarket offering. Revenues remained largely stable at -1%, supported by delivery on orders from recent quarters, but also hampered by a cautious approach from customers.

Key differences in the market situation compared with the year-earlier period:

- significant declines in order intake in the important mining regions of Africa & Middle East, Asia as well as North America. Europe and Australia reported a slight positive development
- order intake declined for mining equipment
- order intake softened slightly for the aftermarket offering
- Europe and Australia reported a positive development in revenues, while other regions declined
- revenues were supported by positive development for equipment due to order intake in previous quarters
- revenues for the aftermarket offering softened slightly

Organic revenues were largely stable, although adjusted operating profit declined by -19%, adversely impacted by changed exchange rates.

Items impacting operating profit and margin:

- changed exchange rates negatively impacted operating profit by about -210 million SEK (240)
- savings from the ongoing supply chain optimization program amounted to 62 million SEK for the quarter, yielding an annual run rate of 248 million SEK

The net working capital was reduced in both absolute and relative terms, and the ratio of net working capital to revenues decreased to 36.5% (38.2).

ORDER INTAKE, REVENUES AND BOOK-TO-BILL

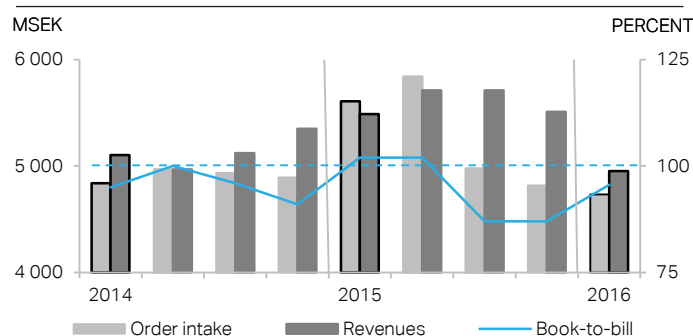

OPERATING PROFIT AND RETURN

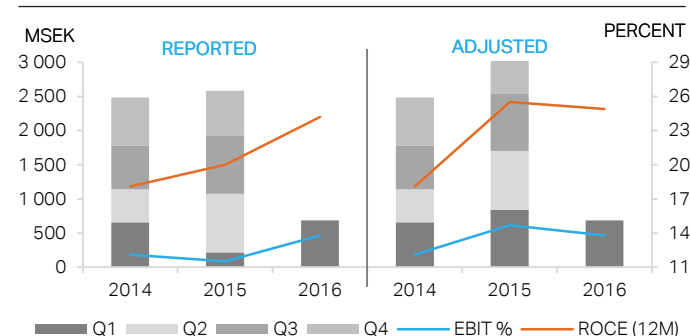

FINANCIAL OVERVIEW, MSEK

Continuing operations

	Q1 2015	Q1 2016	CHANGE %	Q1-4 2015
Order intake	5 610	4 734	-8 *	21 247
Revenues	5 489	4 952	-1 *	22 421
Operating profit	215	685	+219	2 585
% of revenues	3.9	13.8		11.5
Adjusted operating profit**	841	685	-19	3 296
% of revenues**	15.3	13.8		14.7
Return on capital employed, %***	14.8	24.2		20.0
Number of employees	10 424	10 381	-0	10 507

* At fixed exchange rates for comparable units. ** Operating profit adjusted for nonrecurring charges of 626 million SEK in Q1 2015. *** Rolling 12 months.

SANDVIK MINING

CONTINUING OPERATIONS

FINANCIAL OVERVIEW, MSEK	Q1 2015	Q1 2016	CHANGE %	Q1-4 2015
Order intake	5 610	4 734	-8 *	21 247
Revenues	5 489	4 952	-1 *	22 421
Operating profit	215	685	+219	2 585
% of revenues	3.9	13.8		11.5
Adjusted operating profit**	841	685	-19	3 296
% of revenues**	15.3	13.8		14.7

* At fixed exchange rates for comparable units. ** Operating profit adjusted for nonrecurring charges of 626 million SEK in Q1 2015.

DISCONTINUED OPERATIONS

FINANCIAL OVERVIEW, MSEK	Q1 2015	Q1 2016	CHANGE %	Q1-4 2015
Order intake	592	1 162	+114 *	2 781
Revenues	1 374	720	-39 *	4 977
Operating profit	-147	-54	+63	-1 209
% of revenues	-10.7	-7.5		-24.3
Adjusted operating profit**	-43	-54	-27	-108
% of revenues**	-3.1	-7.5		-2.2

* At fixed exchange rates for comparable units. ** Operating profit adjusted for nonrecurring charges of 104 million SEK in Q1 2015.

The underlying market for Mining Systems (discontinued operations) remained challenging as customers continued to postpone projects and consequently, price pressure remained tangible. However, several large orders were received during the first quarter totaling about 800 million SEK, significantly supporting growth in order intake compared with the year-earlier period.

Revenues declined by -39% year on year, at fixed exchange rates for comparable units. The operating loss amounted to -54 million SEK. Changed exchange rates positively impacted earnings by about 20 million SEK.

The divestment of Mining Systems is expected to be completed during 2016.

SANDVIK MINING TOTAL

FINANCIAL OVERVIEW, MSEK	Q1 2015	Q1 2016	CHANGE %	Q1-4 2015
Order intake	6 203	5 895	+4 *	24 028
Revenues	6 863	5 672	-9 *	27 398
Operating profit	68	631	+822	1 375
% of revenues	1.0	11.1		5.0
Adjusted operating profit**	798	631	-21	3 188
% of revenues**	11.6	11.1		11.6

* At fixed exchange rates for comparable units. ** Operating profit adjusted for nonrecurring charges of 730 million SEK in Q1 2015.

SANDVIK MATERIALS TECHNOLOGY

LARGE ORDERS BOOKED,
WEAK GENERAL DEMAND

STABLE UNDERLYING OPERATING
MARGIN

SAVINGS FROM EFFICIENCY
MEASURES



GROWTH

Q1	ORDER INTAKE	REVENUES
Price/volume, %	-6	-12
Structure, %	+0	+0
Currency, %	-1	-1
TOTAL, %	-6	-13

Change compared to same quarter last year. The table is multiplicative, i.e. the different components must be multiplied to determine the total effect.

Organic order intake declined by -6% in a challenging market environment.

Key differences in the market situation compared with the year-earlier period:

- large orders were booked for the capex driven oil & gas-related tubular offering, totaling about 600 million SEK. In the year-earlier period the net of large orders and cancellation was 300 million SEK
- demand for the more standardized tubular offering declined on the account of increased competition and price pressure as companies active in the tubular area sought to replace lost volumes in the oil & gas industry with volumes in adjacent segments
- demand for wire products declined, primarily due to weak demand for welding products in the energy segment

The reported operating margin was 6.7% and the underlying operating margin – adjusted for the impact of metal price effects – was 10.0%, in line with the year-earlier period.

Items impacting operating profit and margin:

- declining volumes had a negative impact on operating profit
- changed exchange rates had a negative impact of about -5 million SEK (70) on operating profit
- changed metal prices had an adverse impact of -106 million SEK (-5) on operating profit
- savings from announced restructuring programs amounted to 31 million SEK in the quarter, yielding an annual run rate of 132 million SEK
- lower rate of inventory reductions supported the operating margin compared with first quarter of 2015

- efficiency measures are ongoing to mitigate the impact from a weak demand environment

Net working capital was reduced year on year and the ratio to revenues decreased to 26.4% (29.7).

ORDER INTAKE, REVENUES AND BOOK-TO-BILL

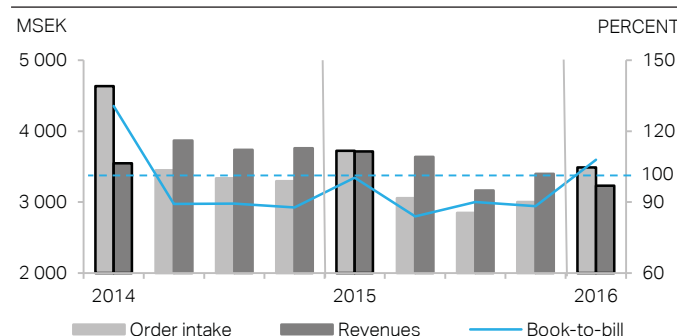

OPERATING PROFIT AND RETURN

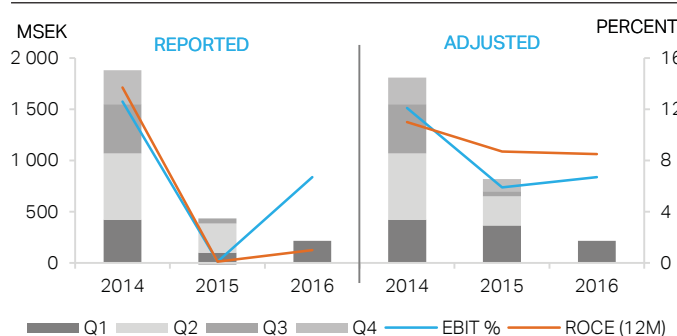

FINANCIAL OVERVIEW, MSEK

	Q1 2015	Q1 2016	CHANGE %	Q1-4 2015
Order intake	3 725	3 488	-6 *	12 625
Revenues	3 712	3 231	-12 *	13 909
Operating profit	100	216	+116	8
% of revenues	2.7	6.7		0.1
Adjusted operating profit**	365	216	-41	818
% of revenues**	9.8	6.7		5.9
Return on capital employed, %***	11.3	1.0		0.1
Number of employees	6 789	6 489	-4	6 533

* At fixed exchange rates for comparable units. ** Operating profit adjusted for nonrecurring charges of 265 million SEK in Q1 2015. *** Rolling 12 months

SANDVIK CONSTRUCTION

POSITIVE BOOK-TO-BILL IN CHALLENGING MARKETS

MARGIN IMPROVEMENT

NEW BUSINESS AREA AS OF 1 JULY 2016 - MINING AND ROCK TECHNOLOGY



GROWTH

Q1	ORDER INTAKE	REVENUES
Price/volume, %	-9	-5
Structure, %	+0	+0
Currency, %	-4	-5
TOTAL, %	-12	-9

Change compared to same quarter last year. The table is multiplicative, i.e. the different components must be multiplied to determine the total effect.

A positive book-to-bill was reported, although market conditions deteriorated and both order intake and revenues declined. Demand for equipment slowed while slight growth was reported in order intake for the aftermarket offering.

Key differences in the market situation compared with the year-earlier period:

- all regions reported declining order intake except for Australia and Asia. Within the Asia region, India noted positive growth, while China weighed on the region as a whole
- equipment for tunneling reported positive order development, primarily in Australia
- demand for mobile crushing equipment weakened generally in all regions

Despite a -5% fall in organic revenues, Sandvik Construction reported growth in adjusted operating profit as well as an improved margin.

Items impacting operating profit and margin:

- improved profitability for equipment product offering, supported by less under-absorption of fixed costs as capacity has been reduced through the supply chain optimization program
- measures within the scope of ongoing program for adjustment of cost base were completed, with savings amounting to 46 million SEK in the quarter, yielding an annual run rate of 184 million SEK

Net working capital in absolute terms reached an all-time low level, noting a decrease in relation to revenues to 22.9% (24.3), compared with the year-earlier period.

ORDER INTAKE, REVENUES AND BOOK-TO-BILL

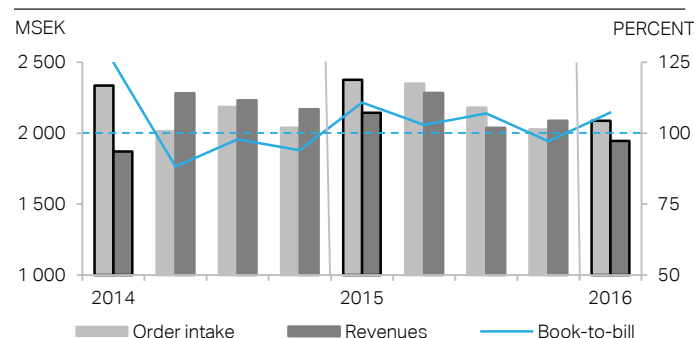

OPERATING PROFIT AND RETURN

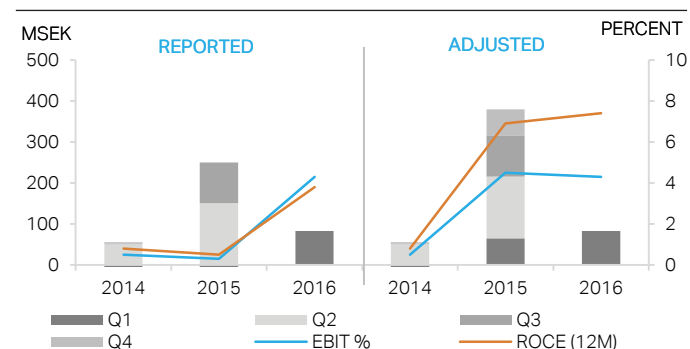

FINANCIAL OVERVIEW, MSEK

	Q1 2015	Q1 2016	CHANGE %	Q1-4 2015
Order intake	2 376	2 087	-9 *	8 928
Revenues	2 144	1 945	-5 *	8 551
Operating profit	-95	83	N/M	28
% of revenues	-4.4	4.3		0.3
Adjusted operating profit**	65	83	+28	381
% of revenues**	3.0	4.3		4.5
Return on capital employed, %***	-0.7	3.8		0.5
Number of employees	2 740	2 956	+8	2 927

* At fixed exchange rates for comparable units, ** Operating profit adjusted for nonrecurring charges of 160 million SEK in Q1 2015, *** Rolling 12 months

SANDVIK VENTURE

POSITIVE BOOK-TO-BILL

CHALLENGING MARKETS

UNDER-UTILIZATION IMPACTED EARNINGS



GROWTH

Q1	ORDER INTAKE	REVENUES
Price/volume, %	-13	-18
Structure, %	+1	+0
Currency, %	-2	-2
TOTAL, %	-14	-19

Change compared to same quarter last year. The table is multiplicative, i.e. the different components must be multiplied to determine the total effect.

Markets were challenging and three of four product areas reported a negative development in order intake. Organic order intake and revenues declined by -13% and -18%, respectively, implying a positive book-to-bill of 1.1.

Key differences in the market situation compared with the year-earlier period:

- Drilling and Completions: weak customer activity in the energy segment, particularly in the North American region, due to low oil prices triggering a continued deterioration in the number of active onshore drill rigs
- Hyperion: weak market conditions in the energy segment in addition to generally low industrial growth hampered demand
- Process Systems: organic order intake remained stable, supported by good development in the project business for industrial processing, resulting in a positive book-to-bill
- Wolfram: positive impact from increased demand for tonnage (volume), although this was more than offset by the deterioration in tungsten market prices

Reported earnings and operating margin were adversely impacted by significant under-absorption of cost base due to a decline in invoiced volumes.

Items impacting operating profit and margin:

- operating margin declined in most business areas, impacted by negative organic growth during the quarter
- price pressure in Drilling and Completions as well as Wolfram
- savings from announced initiatives amounted to 11 million SEK in the quarter, yielding an annual run rate of 44 million SEK

- changed exchange rates had a negative impact on operating profit of about -40 million SEK (30)

ORDER INTAKE, REVENUES AND BOOK-TO-BILL

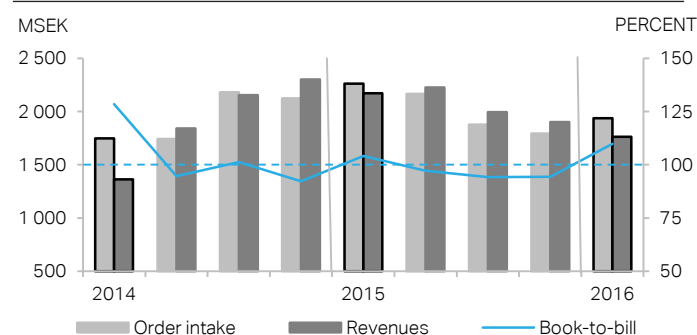

OPERATING PROFIT AND RETURN

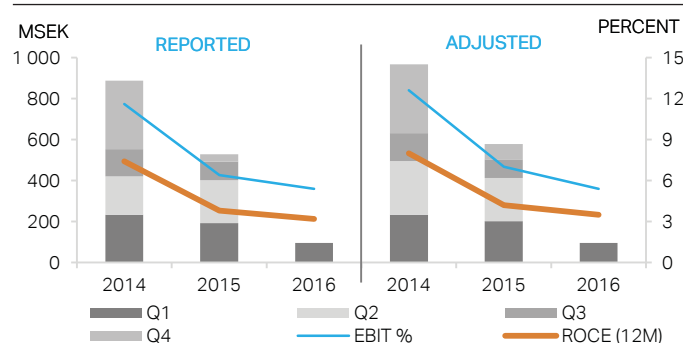

FINANCIAL OVERVIEW, MSEK

	Q1 2015	Q1 2016	CHANGE %	Q1-4 2015
Order intake	2 263	1 936	-13 *	8 097
Revenues	2 172	1 763	-18 *	8 292
Operating profit	192	95	-50	529
% of revenues	8.8	5.4		6.4
Adjusted operating profit**	202	95	-53	579
% of revenues**	9.3	5.4		7.0
Return on capital employed, %***	7.1	3.2		3.8
Number of employees	4 060	3 703	-9	3 829

* At fixed exchange rates for comparable units. ** Operating profit adjusted for nonrecurring charges of 10 million SEK in Q1 2015. *** Rolling 12 months.

PARENT COMPANY

The parent company's revenues for the first quarter of 2016 amounted to 3,863 million SEK (4,242) and the operating result was 166 million SEK (-85). Income from shares in Group companies consists primarily of dividends and Group contributions from these and amounted after the first quarter

to 322 million SEK (39). Interest-bearing liabilities, less cash and cash equivalents and interest-bearing assets, amounted to 9,759 million SEK (6,564). Investments in property, plant and machinery amounted to 151 million SEK (161).

ACQUISITIONS AND DIVESTMENTS

ACQUISITIONS DURING THE MOST RECENT 12-MONTH PERIOD

	COMPANY/UNIT	CLOSING DATE	ANNUAL REVENUE, MSEK	NO OF EMPLOYEES
Sandvik Machining Solutions	Prometec GmbH	25 January 2016	48	35
Sandvik Venture	SGL Technology B.V.	15 September 2015	60	20

DIVESTMENTS DURING THE MOST RECENT 12-MONTH PERIOD

No divestments in the period.

SIGNIFICANT EVENTS

– On 16 March Sandvik announced it will merge its Sandvik Mining and Sandvik Construction operations into one business area – Sandvik Mining and Rock Technology.

Sandvik Mining and Rock Technology's operations will have a decentralized business model with separate product areas based on the product offerings. Each product area will have full responsibility and accountability for its respective business.

The new structure will take effect as from 1 July 2016 and Lars Engström, currently President of Sandvik Mining, has been appointed President of the new Sandvik Mining and Rock Technology business area.

Dinggui Gao, President of Sandvik Construction, will leave the company as of 1 July 2016.

– On 1 April, Tomas Eliasson joined Sandvik as Executive Vice President and CFO.

GUIDANCE

Guidance below relates to continuing operations.

Sandvik does not provide a market outlook or business performance forecasts. However, guidance relating to certain non-operational key figures considered useful when modeling financial outcomes is provided in the table below:

CAPEX	Estimated at below 4.1 billion SEK for 2016
CURRENCY EFFECTS	Based on currency rates at end-March 2016, it is estimated that operating profit for the second quarter of 2016 will be impacted by transaction and translation currency effects of about -500 million SEK, compared with the year-earlier
METAL PRICE EFFECTS	In view of currency rates, stock levels and metal prices at the end of March 2016, it is estimated that operating profit for the second quarter of 2016 will be impacted by about -50 million SEK
NET FINANCIAL ITEMS	Estimated at between -1.7 and -1.9 billion SEK in 2016
TAX RATE	Estimated at about 26-28% for 2016

ACCOUNTING POLICIES

This interim report was prepared in accordance with IFRS, applying IAS 34, Interim Financial Reporting. The same accounting and valuation policies were applied as in the most recent annual report with the exception of new and revised standards and interpretations effective from 1 January 2016.

The interim report for the Parent Company has been prepared in accordance with the Annual Accounts Act and the Securities Market Act, which is in line with standard RFR 2 Reporting by a legal entity, issued by the Swedish Financial Reporting Board.

IASB has published amendments of standards that are effective as of 1 January 2016 or later. The standards have not had

any material impact on the consolidated accounts. Disclosure in accordance with IAS 34.16A is found in the financial statements, the related notes and also in other parts of the interim report.

The Mining Systems operations, which the Group intends to divest, have been classified as discontinued operations in accordance with IFRS 5. Comparative figures have been adjusted where necessary. In connection with the ongoing divestment, a write-down of assets has been made to a value that corresponds to the estimated sale price less selling costs. The divestment is expected to be completed during 2016.

TRANSACTIONS WITH RELATED PARTIES

No transactions between Sandvik and related parties that significantly affected the company's position and results took place.

RISK ASSESSMENT

Sandvik is a global group represented in 150 countries and as such is exposed to a number of commercial and financial risks. Accordingly, risk management is an important process for Sandvik in its work to achieve established targets. Efficient risk management forms part of the ongoing review of the business

and forward-looking assessment of operations. Sandvik's long-term risk exposure is assumed not to deviate from the inherent exposure associated with Sandvik's ongoing business operations. For a more in-depth analysis of risks, refer to Sandvik's Annual Report for 2015.

FINANCIAL REPORTS SUMMARY

THE GROUP

INCOME STATEMENT

MSEK	Q1 2015	Q1 2016	CHANGE %	Q1-4 2015
<i>Continuing operations</i>				
Revenues	21 960	19 700	-10	85 845
Cost of sales and services	-14 621	-12 086	-17	-55 239
Gross profit	7 339	7 614	+4	30 606
% of revenues	33.4	38.6		35.7
Selling expenses	-3 506	-2 873	-18	-13 116
Administrative expenses	-1 942	-1 518	-22	-7 079
Research and development costs	-756	-703	-7	-3 001
Other operating income and expenses	64	-107	N/M	-139
Operating profit	1 199	2 413	+101	7 271
% of revenues	5.5	12.2		8.5
Net financial items	-478	-417	-13	-1 963
Profit after financial items	720	1 996	+177	5 308
% of revenues	3.3	10.1		6.2
Income tax	-153	-541	+253	-1 865
Profit for the period, continuing operations	567	1 455	+157	3 443
% of revenues	2.6	7.4		4.0
<i>Discontinued operations</i>				
Revenues	1 374	720	-48	4 977
Operating profit	-147	-54	+63	-1 209
Profit after financial items	-157	-57	+64	-1 249
Profit for the period, discontinued operations	-157	-57	+64	-1 249
<i>Group total</i>				
Revenues	23 334	20 420	-12	90 822
Operating profit	1 052	2 359	+124	6 062
Profit after financial items	563	1 939	+244	4 059
Profit for the period, Group total	410	1 398	+241	2 194
<i>Items that will not be reclassified to profit or loss</i>				
Actuarial gains/(losses) on defined benefit pension plans	-674	-31		589
Tax relating to items that will not be reclassified	159	15		-139
	-515	-16		450
<i>Items that will be reclassified subsequently to profit or loss</i>				
Foreign currency translation differences	709	-1		-972
Cash flow hedges	-125	-31		55
Tax relating to items that may be reclassified	27	8		-7
	611	-24		-924
Total other comprehensive income	96	-40		-474
Total comprehensive income	506	1 358		1 720
Profit for the period attributable to				
Owners of the Parent	415	1 403		2 247
Non-controlling interests	-5	-5		-53
Total comprehensive income attributable to				
Owners of the Parent	511	1 363		1 770
Non-controlling interests	-5	-5		-50
Earnings per share, SEK *				
Continuing operations	0.46	1.16		2.79
Discontinued operations	-0.13	-0.04		-1.00
Group Total	0.33	1.12		1.79
Adjusted Group Total	1.43	1.12		4.37

* No dilution effects during the period, N/M = non-meaningful

THE GROUP

BALANCE SHEET

CONTINUING AND DISCONTINUED OPERATIONS

MSEK	31 DEC 2015	31 MAR 2015	31 MAR 2016
Intangible assets	18 313	19 166	18 177
Property, plant and equipment	26 331	27 858	25 952
Financial assets	7 814	8 781	8 001
Inventories	21 522	24 571	21 543
Current receivables	18 767	23 349	19 058
Cash and cash equivalents	6 376	7 318	7 170
Assets held for sale	2 119	-	2 223
Total assets	101 242	111 043	102 124
Total equity	34 060	37 199	35 443
Non-current interest-bearing liabilities	35 610	42 655	35 707
Non-current non-interest-bearing liabilities	4 262	3 989	4 307
Current interest-bearing liabilities	5 190	2 908	5 037
Current non-interest-bearing liabilities	20 231	24 292	19 863
Liabilities held for sale	1 889	-	1 767
Total equity and liabilities	101 242	111 043	102 124
<i>Group total</i>			
Net working capital*	21 726	26 188	22 395
Loans	34 439	37 554	34 309
Net pension liabilities	5 918	7 536	5 966
Net debt**	28 173	30 391	27 246
Net debt to equity ratio***	0.74	0.72	0.69
Non-controlling interests in total equity	81	126	80

* Inventories plus trade receivables excl. prepaid income taxes, reduced by non-interest-bearing liabilities excl. tax liabilities

** Current and non-current interest-bearing liabilities excluding net provisions for pensions, less cash and cash equivalents.

*** Equity excluding accumulated actuarial gains/losses on defined benefit pension plans after tax

CHANGE IN TOTAL EQUITY

MSEK	EQUITY RELATED TO OWNERS OF THE PARENT	NON-CONTROLLING INTEREST	TOTAL EQUITY
Opening equity, 1 January 2015	36 538	134	36 672
Total comprehensive income for the period	1 770	-50	1 720
Personnel options program	17	-	17
Hedge of personnel options program	44	-	44
Dividends	-4 390	-3	-4 393
Closing equity, 31 December 2015	33 979	81	34 060
Opening equity, 1 January 2016	33 979	81	34 060
Total comprehensive income for the period	1 363	-5	1 358
Non-controlling interest new stock issue	-	4	4
Personnel options program	21	-	21
Closing equity, 31 March 2016	35 363	80	35 443
Opening equity, 1 January 2015	36 538	134	36 672
Total comprehensive income for the period	511	-5	506
Personnel options program	23	-	23
Dividends	-	-3	-3
Closing equity, 31 March 2015	37 072	126	37 199

THE GROUP

CASH FLOW STATEMENT

MSEK	Q1 2015	Q1 2016	Q1-4 2015
<i>Continuing operations</i>			
<i>Cash flow from operating activities</i>			
Income after financial income and expenses	720	1 996	5 308
Adjustment for depreciation, amortization and impairment losses	1 261	1 074	5 321
Adjustment for items that do not require the use of cash etc.	1 372	-110	1 389
Income tax paid	-542	-546	-1 939
Cash flow from operations before changes in working capital, continuing operations	2 811	2 414	10 079
<i>Changes in working capital</i>			
Change in inventories	325	-59	2 108
Change in operating receivables	-1 004	-570	845
Change in operating liabilities	594	-107	188
Cash flow from changes in working capital, continuing operations	-85	-736	3 141
Investments in rental equipment	-135	-137	-625
Divestments of rental equipment	79	61	198
Cash flow from operations, continuing operations	2 670	1 602	12 793
<i>Cash flow from investing activities</i>			
Acquisitions of companies and shares, net of cash	-	-37	-7
Investments in tangible assets	-756	-521	-3 152
Proceeds from sale of tangible assets	34	76	245
Investments in intangible assets	-37	-220	-942
Proceeds from sale of intangible assets	-	-	7
Other investments, net	-9	-8	-16
Cash flow from investing activities, continuing operations	-768	-710	-3 865
Net cash flow after investing activities	1 902	892	8 928
<i>Cash flow from financing activities</i>			
Change in interest-bearing debt	-788	176	-3 570
Dividends paid	-	-	-4 393
Cash flow from financing activities, continuing operations	-788	176	-7 963
Cash flow from continuing operations	1 114	1 068	965
Cash flow from discontinued operations	-231	-267	-886
Cash flow for the period, Group total	883	801	79
Cash and cash equivalents at beginning of the period	6 327	6 376	6 327
Exchange-rate differences in cash and cash equivalents	108	-7	-30
Cash and cash equivalents at the end of the period	7 318	7 170	6 376
<i>Discontinued operations</i>			
Cash flow from operations	-239	-88	-841
Cash flow from investing activities	9	-178	-45
Cash flow from financing activities	-1	-1	-
<i>Group Total</i>			
Cash flow from operations	2 431	1 514	11 952
Cash flow from investing activities	-759	-888	-3 910
Cash flow from financing activities	-789	175	-7 963
Group total cash flow	883	801	79

THE PARENT COMPANY

INCOME STATEMENT

MSEK	Q1 2015	Q1 2016
Revenues	4 242	3 863
Cost of sales and services	-2 675	-2 434
Gross profit	1 567	1 429
Selling expenses	-153	-189
Administrative expenses	-621	-376
Research and development costs	-353	-344
Other operating income and expenses	-525	-354
Operating profit	-85	166
Income from shares in Group companies	39	322
Interest income/expenses and similar items	-149	-134
Profit after financial items	-195	354
Income tax expense	-221	-85
Profit for the period	-416	269

BALANCE SHEET

MSEK	31 DEC 2015	31 MAR 2015	31 MAR 2016
Intangible assets	20	8	237
Property, plant and equipment	7 725	7 686	7 602
Financial assets	47 139	46 933	48 029
Inventories	3 186	3 802	3 046
Current receivables	15 727	15 294	14 585
Cash and cash equivalents	1	1	1
Total assets	73 798	73 724	73 500
Total equity	31 997	28 940	32 287
Untaxed reserves	11	4	11
Provisions	748	511	760
Non-current interest-bearing liabilities	21 002	25 705	21 185
Non-current non-interest-bearing liabilities	59	59	79
Current interest-bearing liabilities	14 112	6 015	13 270
Current non-interest-bearing liabilities	5 869	12 490	5 908
Total equity and liabilities	73 798	73 724	73 500
Contingent liabilities	15 583	16 975	15 292
Interest-bearing liabilities and provisions minus cash and cash equivalents and interest-bearing assets	11 132	6 564	9 759
Investments in fixed assets	907	161	151

MARKET OVERVIEW, THE GROUP

ORDER INTAKE AND REVENUES PER MARKET AREA - FIRST QUARTER 2016

MARKET AREA	ORDER INTAKE	CHANGE *		SHARE	REVENUES	CHANGE *	SHARE
	MSEK	%	% ¹⁾	%	MSEK	%	%
THE GROUP							
Europe	8 805	+7	-3	42	7 966	-7	44
North America	4 048	-26	-14	20	4 196	-10	20
South America	977	-4	-4	5	958	-12	5
Africa/Middle East	1 548	-16	-16	8	1 718	-10	8
Asia	4 027	-8	-8	20	3 828	-5	18
Australia	894	+5	+5	5	1 034	+22	5
Total continuing operations	20 299	-7	-7	100	19 700	-7	100
Discontinued operations	1 162	+114	-20	-	720	-39	-
Group total	21 461	-4	-8	-	20 420	-8	-
SANDVIK MACHINING SOLUTIONS							
Europe	4 468	+0	+0	55	4 326	+0	55
North America	1 722	-10	-10	21	1 700	-14	22
South America	144	-17	-17	2	145	-20	2
Africa/Middle East	78	+42	+42	1	68	+20	1
Asia	1 585	-8	-8	20	1 512	-7	19
Australia	53	+4	+4	1	52	+4	1
Total	8 050	-4	-4	100	7 803	-5	100
SANDVIK MINING							
Europe	545	+3	+3	11	564	+6	12
North America	790	-13	-13	17	853	-0	17
South America	593	-2	-2	13	579	-7	12
Africa/Middle East	1 026	-16	-16	22	1 201	-4	24
Asia	1 065	-8	-8	22	989	-2	20
Australia	715	+3	+3	15	766	+6	15
Total continuing operations	4 734	-8	-8	100	4 952	-1	100
Discontinued operations	1 162	+114	-20	-	720	-39	-
Sandvik Mining total	5 895	+4	-10	-	5 672	-9	-
SANDVIK MATERIALS TECHNOLOGY							
Europe	2 263	+65	+3	59	1 600	-23	50
North America	536	-64	-28	18	873	+5	27
South America	50	+13	+13	2	46	+14	1
Africa/Middle East	47	-46	-46	2	55	-32	2
Asia	584	-19	-19	19	647	+2	20
Australia	8	-50	-50	0	10	-31	0
Total	3 488	-6	-10	100	3 231	-12	100
SANDVIK CONSTRUCTION							
Europe	776	-10	-10	38	750	-3	38
North America	531	-13	-13	25	374	-13	19
South America	98	-4	-4	5	112	-24	6
Africa/Middle East	196	-31	-31	9	189	-42	10
Asia	401	+4	+4	19	344	+4	18
Australia	85	+63	+63	4	176	+442	9
Total	2 087	-9	-9	100	1 945	-5	100
SANDVIK VENTURE							
Europe	754	-23	-23	39	729	-15	41
North America	464	-16	-16	24	390	-27	22
South America	91	+3	+3	5	75	-26	4
Africa/Middle East	201	-1	-1	10	204	-3	12
Asia	393	+3	+3	20	335	-17	19
Australia	33	-18	-18	2	30	-1	2
Total	1 936	-13	-13	100	1 763	-18	100

* At fixed exchange rates for comparable units compared with the year-earlier period

1) Excluding major orders

THE GROUP

ORDER INTAKE BY BUSINESS AREA

MSEK	Q1 2015	Q2 2015	Q3 2015	Q4 2015	Q1-4 2015	Q1 2016	CHANGE Q1 % % ¹⁾	
<i>Continuing operations</i>								
Sandvik Machining Solutions	8 596	8 355	7 841	7 890	32 682	8 050	-6	-4
Sandvik Mining	5 610	5 840	4 977	4 819	21 247	4 734	-16	-8
Sandvik Materials Technology	3 725	3 054	2 847	2 999	12 625	3 488	-6	-6
Sandvik Construction	2 376	2 348	2 179	2 026	8 928	2 087	-12	-9
Sandvik Venture	2 263	2 165	1 878	1 792	8 097	1 936	-14	-13
Group activities	4	4	4	5	18	4		
Continuing operations	22 574	21 766	19 726	19 531	83 597	20 299	-10	-7
Discontinued operations	592	977	466	745	2 781	1 162	+96	+114
Group total	23 167	22 743	20 192	20 275	86 378	21 461	-7	-4

REVENUES BY BUSINESS AREA

MSEK	Q1 2015	Q2 2015	Q3 2015	Q4 2015	Q1-4 2015	Q1 2016	CHANGE Q1 % % ¹⁾	
<i>Continuing operations</i>								
Sandvik Machining Solutions	8 438	8 339	7 836	8 039	32 652	7 803	-8	-5
Sandvik Mining	5 489	5 710	5 712	5 509	22 421	4 952	-10	-1
Sandvik Materials Technology	3 712	3 639	3 161	3 398	13 909	3 231	-13	-12
Sandvik Construction	2 144	2 283	2 037	2 087	8 551	1 945	-9	-5
Sandvik Venture	2 172	2 226	1 994	1 901	8 292	1 763	-19	-18
Group activities	5	3	5	6	20	6		
Continuing operations	21 960	22 200	20 745	20 940	85 845	19 700	-10	-7
Discontinued operations	1 374	1 198	1 347	1 058	4 977	720	-48	-39
Group total	23 334	23 398	22 092	21 998	90 822	20 420	-12	-8

OPERATING PROFIT BY BUSINESS AREA

MSEK	Q1 2015	Q2 2015	Q3 2015	Q4 2015	Q1-4 2015	Q1 2016	CHANGE Q1 %	
<i>Continuing operations</i>								
Sandvik Machining Solutions	1 129	1 701	1 459	981	5 269	1 587	+41	
Sandvik Mining	215	860	847	663	2 585	685	+219	
Sandvik Materials Technology	100	286	49	-427	8	216	+116	
Sandvik Construction	-95	151	99	-128	28	83	N/M	
Sandvik Venture	192	210	91	36	529	95	-50	
Group activities	-342	-231	-220	-355	-1 148	-253		
Continuing operations	1 199	2 977	2 325	770	7 271	2 413	+101	
Discontinued operations	-147	-74	-1 004	16	-1 209	-54	+63	
Group total²⁾	1 052	2 903	1 321	786	6 062	2 359	+124	

OPERATING MARGIN BY BUSINESS AREA

%	Q1 2015	Q2 2015	Q3 2015	Q4 2015	Q1-4 2015	Q1 2016
<i>Continuing operations</i>						
Sandvik Machining Solutions	13.4	20.4	18.6	12.2	16.1	20.3
Sandvik Mining	3.9	15.1	14.8	12.0	11.5	13.8
Sandvik Materials Technology	2.7	7.9	1.5	-12.6	0.1	6.7
Sandvik Construction	-4.4	6.6	4.9	-6.1	0.3	4.3
Sandvik Venture	8.8	9.5	4.6	1.9	6.4	5.4
Continuing operations	5.5	13.4	11.2	3.7	8.5	12.2
Discontinued operations	-10.7	-6.2	-74.6	1.5	-24.3	-7.5
Group total	4.5	12.4	6.0	3.6	6.7	11.6

1) Change compared with preceding year at fixed exchange rates for comparable units

2) Internal transactions had negligible effect on business area profits

N/M = non-meaningful

THE GROUP

ADJUSTED OPERATING PROFIT BY BUSINESS AREA

MSEK	Q1 2015	Q2 2015	Q3 2015	Q4 2015	Q1-4 2015	Q1 2016	CHANGE Q1 %
<i>Continuing operations</i>							
Sandvik Machining Solutions	1 809	1 701	1 459	1 611	6 579	1 587	-12
Sandvik Mining	841	860	847	749	3 296	685	-19
Sandvik Materials Technology	365	286	49	118	818	216	-41
Sandvik Construction	65	151	99	65	381	83	+28
Sandvik Venture	202	210	91	76	579	95	-53
Group activities	-306	-231	-220	-304	-1 061	-253	
Continuing operations	2 977	2 977	2 325	2 315	10 593	2 413	-19
Discontinued operations	-43	-74	-6	16	-108	-54	-27
Group total ²⁾	2 934	2 903	2 319	2 331	10 485	2 359	-20

ADJUSTED OPERATING MARGIN BY BUSINESS AREA

%	Q1 2015	Q2 2015	Q3 2015	Q4 2015	Q1-4 2015	Q1 2016
<i>Continuing operations</i>						
Sandvik Machining Solutions	21.4	20.4	18.6	20.0	20.1	20.3
Sandvik Mining	15.3	15.1	14.8	13.6	14.7	13.8
Sandvik Materials Technology	9.8	7.9	1.5	3.5	5.9	6.7
Sandvik Construction	3.0	6.6	4.9	3.1	4.5	4.3
Sandvik Venture	9.3	9.5	4.6	4.0	7.0	5.4
Continuing operations	13.6	13.4	11.2	11.1	12.3	12.2
Discontinued operations	-3.1	-6.2	-0.5	1.5	-2.2	-7.5
Group total	12.6	12.4	10.5	10.6	11.5	11.6

1) Change compared with preceding year at fixed exchange rates for comparable units

2) Internal transactions had negligible effect on business area profits

N/M = non-meaningful

KEY FIGURES

	Q1 2015	Q1 2016	Q1-4 2015
<i>Continuing operations</i>			
Tax rate, %	21.3	27.1	35.1
Return on capital employed, % ²⁾	11.9	11.2	9.5
Return on total equity, % ²⁾	14.7	12.3	9.7
Return on total capital, % ²⁾	9.1	8.5	7.2
Shareholders' equity per share, SEK	29.6	28.2	27.1
Net debt/equity ratio	0.72	0.69	0.74
Equity/assets ratio, %	34	35	34
Net working capital, %	29	28	27
Earnings per share, SEK	0.46	1.16	2.79
Cash flow from operations, MSEK	+2 670	+1 602	+12 793
Number of employees	45 645	44 031	44 663

	Q1 2015	Q1 2016	Q1-4 2015
<i>Group total</i>			
Tax rate, %	27.2	27.9	45.9
Return on capital employed, % ²⁾	11.5	9.7	7.9
Return on total equity, % ²⁾	13.9	9.1	6.2
Return on total capital, % ²⁾	8.6	7.2	5.9
Shareholders' equity per share, SEK	29.6	28.2	27.1
Net debt/equity ratio	0.72	0.69	0.74
Equity/assets ratio, %	33	35	34
Net working capital, %	28	27	26
Earnings per share, SEK	0.33	1.12	1.79
Cash flow from operations, MSEK	+2 431	+1 514	+11 952
Number of employees	46 856	45 101	45 808
No. of shares outstanding at end of period ('000) ¹⁾	1 254 386	1 254 386	1 254 386
Average no. of shares('000) ¹⁾	1 254 386	1 254 386	1 254 386

1) No dilution effect during the period.

2) Rolling 12 months

DISCLAIMER STATEMENT

Some statements herein are forward-looking and the actual outcome could be materially different. In addition to the factors explicitly commented upon, the actual outcome could be materially affected by other factors, for example the effect of economic conditions, exchange-rate and interest-rate move-

ments, political risks, impact of competing products and their pricing, product development, commercialization and technological difficulties, supply disturbances, and major customer credit losses.

Stockholm 25 April 2016
Sandvik Aktiebolag (publ)

Björn Rosengren
President and CEO

AUDIT

The Company's Auditor has not carried out any review of the report for the first quarter of 2016.

Sandvik AB discloses the information provided herein pursuant to the Securities Markets Act and/or the Financial Instruments Trading Act. The information is submitted for publication on 25 April 2016 at about 13:30 CET.

Additional information may be obtained from Sandvik Investor Relations at tel +46 8 456 14 94 (Ann-Sofie Nordh), +46 8 456 11 94 (Anna Vilogorac) or by e-mailing info.ir@sandvik.com.

A presentation and teleconference will be held on 25 April 2016 at 15:00 CET at the World Trade Center in Stockholm.

Information is available at www.sandvik.com/ir

CALENDAR 2016:

28 April	Annual General Meeting in Sandviken
2 May	Record date for dividend
24 May	Capital Markets Day in Sandviken, Sweden
18 July	Report, second quarter 2016
24 October	Report, third quarter 2016

Sandvik AB, Corp. Reg. No.: 556000-3468
Box 510
SE-101 30 Stockholm
+46 8 456 11 00